

Vibrations-Generator

Der Vibrations-Generator kann mit jedem Funktionsgenerator mit Leistungsausgang betrieben werden (z. B. CL1181). Impedanz ca. 3 Ohm, Leistungsbedarf ca. 3 W, Frequenz min. 0,1 Hz. Die Versuchsmöglichkeiten sind beim nachstehend erwähnten Zubehör beschrieben. Abmessung: 100x100x90 mm, Gewicht 1,8 kg.

◆ **CL5130**

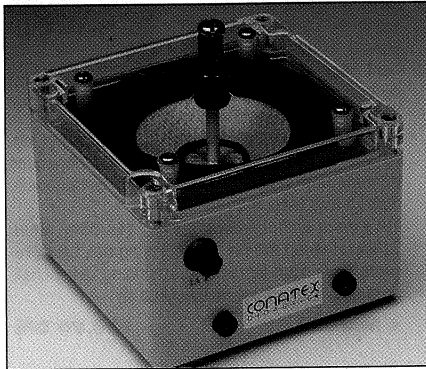

Spannung: ca. 6V bei 1A

Zubehör-Satz

In diesem Zubehör-Satz sind Teile für folgende Versuche enthalten: Kugeln verschiedener Durchmesser, Behälter und Kolben für Versuche zur kinetischen Gastheorie. Spiralfeder, Gummischnüre, Piano-Draht für Transversal- und Longitudinalwellen, schräg zugeschnittenes Gummiband.

Platten zur Demonstration Chladnischer Klang-figuren. Blattfedern aus Stahl verschiedener Abmessungen zur Demonstration unterschiedlicher Resonanzfrequenzen. Verschiedene Erreger für Wasserwellen; Projektion mit Tageslichtprojektor möglich.

CL5131

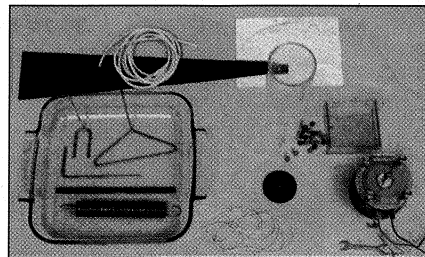

CL5130 Vibrationsgenerator

CL5131 Zubehör-Satz

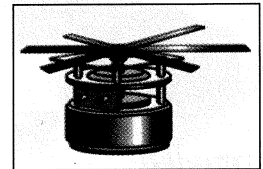

Schwingungen und Resonanz von Blechstreifen

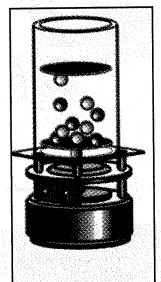

Kinetische Gastheorie

EXPERIMENTS USING VIBRATION GENERATOR & ACCESSORIES (061.441 & 061.442)

KINETIC THEORY DEMONSTRATION

Screw the black disc to the armature and place the perspex tube over. Set frequency to about 50 Hz; insert say 10 orange balls, and raise output to about 1 V. The motion represents molecules gradually changing places, but never becoming very far apart – as in a liquid. Raise the output voltage to raise the average kinetic energy (temperature) of the "molecules". Evaporation is represented when one "molecule" acquires enough energy to escape, momentarily, from its neighbours. When output voltage is a maximum, the average separation between "molecules" may be more than say 10 diameters, representing a gas. At this stage, a piece of expanded polystyrene packing material, cut to a rough circle of diameter 5 cm, may be dropped in. This shows how the "molecules" are able to exert an upward force, by repeated random collision (gas pressure). Diffusion may be illustrated by dropping one blue "molecule" into 10 orange "molecules" which are vibrating slightly (say 1.5 V at 50 Hz). The same demonstration could represent the behaviour of a conduction electron in a metal when **not** carrying a current.

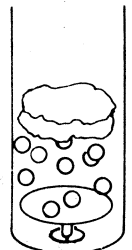

Fig. 10

LONGITUDINAL STANDING WAVES

Hook lower end of coil spring to armature and upper end to a fixed point about 1 metre above. Wait for transients to die down, then **slowly** raise voltage at about 15 Hz. By carefully varying the frequency a longitudinal standing wave will be produced. Now by turning the vibrator onto its side, transverse standing waves may be set up in the same spring. It is apparent that the speed of transverse waves is not the same as the speed of longitudinal waves. In Nuffield 'A' Physics Unit 10 p.81, the need to illustrate standing waves of **non-constant wavelength** is explained. The next two accessories help demonstrate figs. 40, 42 and 43. These accessories are also sometimes demonstrated at 'O' level when considering wave properties in more detail.

WAVES AT A BOUNDARY

Knot together the thick and thin rubber cords. Secure the thin one about 50 cm from the knot to the vibrator and hold the thick one about 50 cm from the knot. Using a frequency of about 15 Hz and light tension, two sets of standing waves may be obtained. Those in the thicker cord have half the speed (and therefore half the wavelength) of those in the thinner cord.

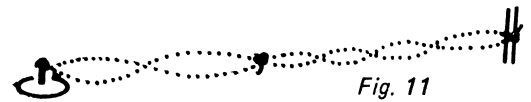

Fig. 11

TAPERED RUBBER STRIP

Hook the narrow end over the vibrator, and fix the broad end to a bench top with 3 drawing pins. Apply about 60 Hz at full voltage, and adjust tension by moving vibrator, until about 5 nodes can be seen. Note variation of wavelength (speed) with width.

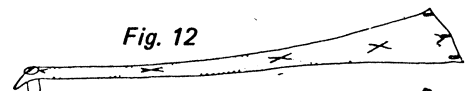

Fig. 12

RESONANCE OF METAL STRIPS

Screw all 3 strips, spaced by about 60°, to the armature. Apply full voltage and observe sharp fundamental resonances at about 11, 15, 21, 36 and 50 Hz. Very interesting harmonics may be seen at frequencies up to about 300 Hz, and heard up to about 900 Hz.

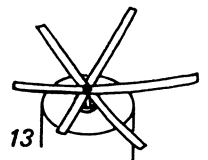

Fig. 13

CONATEX - DIDACTIC Lehrmittel GmbH
D - 66514 Neunkirchen - Postfach 1407
D - 66539 Neunkirchen - Rombachstraße 65

Telefon: 06821-453 9411-0
Telefax: 06821-4411
Telex: 444851 codid

CHLADNI PLATE RESONANCES

Screw the stiff rectangular plate to the armature and place the vibration generator in a tray on a level surface. (The tray is to catch powder which falls off the Chladni plate during the experiments). Sprinkle lightly with any dark freely running powder, e.g. sand. With output set to about 3 volts, raise frequency slowly through the 100 to 1000 Hz range. At several frequencies the plate can be heard to resonate, whereupon powder will move until it reaches nodal lines. Signal voltage may be raised to increase the effect. After a few seconds at any resonant frequency, turn signal down to zero, to observe the position of the nodal lines.

Examples of Chladni patterns:

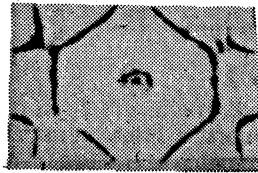

460 Hz

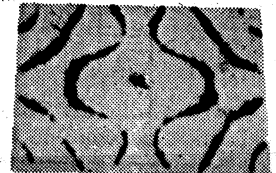

1000 Hz

Fig. 14

Fig. 15

RIPPLE TANK ACCESSORIES

The single, twin and line dippers are attached by pushing into the transverse hole at the top of the vibrator. The clear dish supplied may be used, with the vibrator, on most overhead projectors.

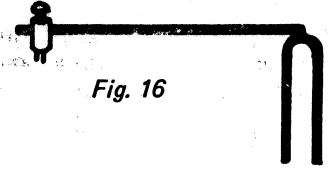

Fig. 16

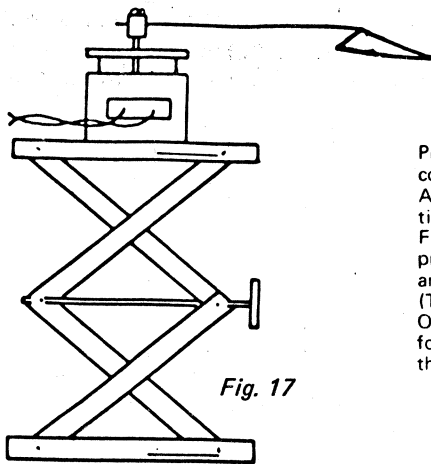

Fig. 17

Place the glass dish on an overhead projector and add water to a depth of 3.5 mm, i.e. just sufficient to cover one of the clear acrylic 'shells' when it is laid flat in the dish.

Attach the 'plane wave' dipper (fig. 17) to the nut on top of the vibration generator spindle, and tighten.

Fix the vibration generator at one side of the ripple tank, preferably **not** standing on the overhead projector. An adjustable table, fig. 17, is convenient if available. (This reduces unwanted ripples). Raise and lower the vibration generator until the horizontal part of the dipper just touches the water surface. (The stem of the dipper may be bent slightly if desired).

Operate the vibration generator at 10 to 25 Hz, varying the amplitude for best effect. Adjust OHP focus for clearest view of waves. (In many experiments it helps if students view the projector image through a disc-type stroboscope).

To show Reflection (fig. 18).

Insert one of the clear shells so that plane ripples bounce off it. Avoid an angle of incidence of 45° as this is the one angle which does not show the law of reflection unambiguously.

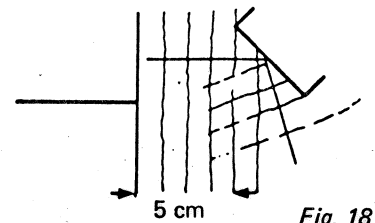

Fig. 18

To show Diffraction (fig. 19).

Place two shells to create a gap of width about 15 mm. Note how the lines of maximum disturbance change position as the frequency is varied.

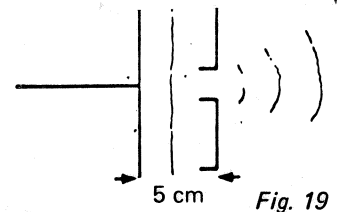

Fig. 19

To show Refraction (fig. 20).

Place one shell flat, so that the 90 x 90 mm. face is just covered with water. Note that, in this shallow water, the wave speed is less than in the rest of the dish. Vary the position and angle of the shell, and the frequency and amplitude of vibrations, for best effect.

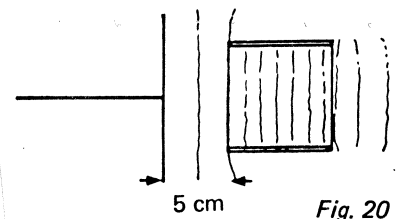

Fig. 20

To show Interference (fig. 21).

Remove shells and any other obstacles, and replace the 'plane wave' dipper with the twin point dipper. Adjust so that points just touch water surface. Vary frequency from about 10 to about 30 Hz, and notice how the interference pattern changes shape. A similar phenomenon accounts for poor reception of television signals when the aerial is placed only a metre or so from a point of very good reception.

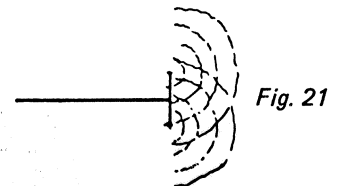

Fig. 21

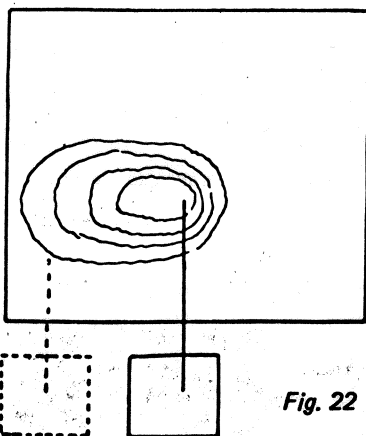

Fig. 22

To show Doppler Effect (fig. 22).

Insert the single-ended dipper near one corner of the tank. Place two thin sheets of polythene between vibration generator base and table top, and slide generator and dipper along at about 10 cm s^{-1} , so that the wave source is travelling at about $\frac{1}{4}$ wave velocity. Note how an imaginary observer, towards whom the source is travelling, would perceive waves of higher frequency than that of the source. An observer from whom the source is receding would perceive waves of lowered frequency.